

Cast Concrete Elements

WASHBASIN

LIGHTING

WALL TILES

ACCESORIES

Urbi et Orbi

Cast concrete elements

Our people ... a team created at random...
since then though , nothing has been left to chance.

Urbi et Orbi Studio

In co-operation with:

2vlo Design team

Venetsanos Dimitris / Architect

Raptis Konstantinos / Architect

Papadopoulos Polivios / Architect

Raptis Elias / graphics

Valentino Marengo / product designer & visual artist

WASHBASIN



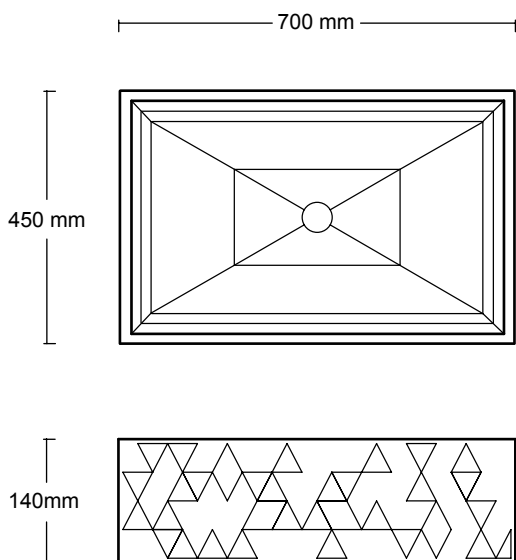

TRACCIA

70 x 45 CM

H: 14 CM

⚖️ 28 KG

design by Valentino Marengo
2017



OMBRA

58 x 38 CM

H: 16 CM

⚖ 25 KG

design by Valentino Marengo
2017

580 mm

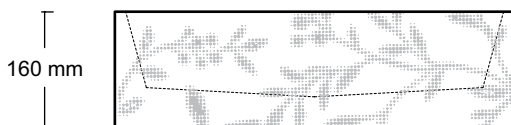
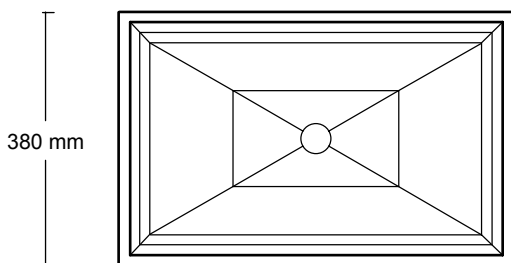



330 mm

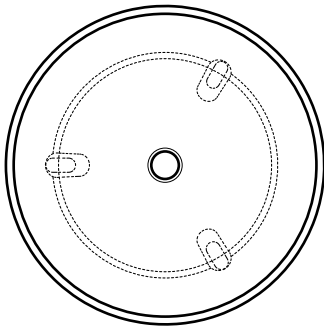

435 mm

125 mm

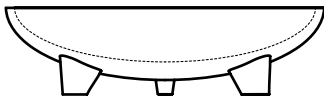

CALDERA

D: 43.5 CM
BASE: 33 CM
H: 12.5 CM

7 KG

design by Valentino Marengo
2017

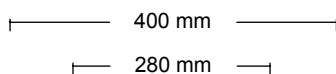

BULBO

D: 40 x 36.5
BASE: 28 CM
H: 18 CM

⚖ 14 KG

design by Valentino Marengo
2017

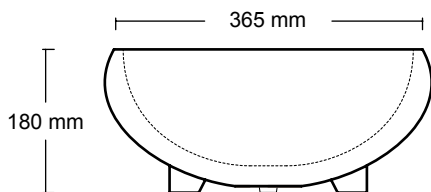
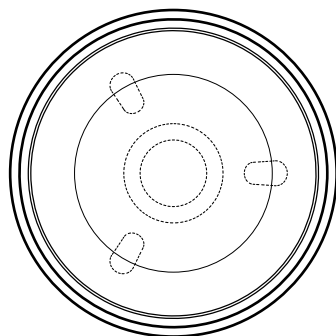



345 mm

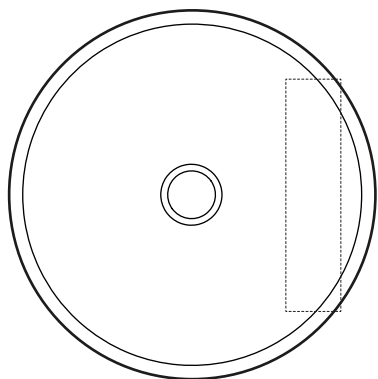

140 mm

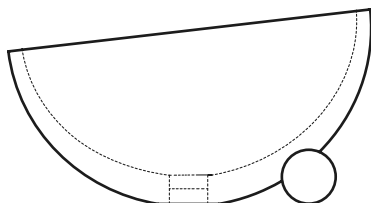

185 mm

OBLIQUO

D: 34.5 CM
H: 18.5 x 14 CM

7 KG

design by Valentino Marengo
2017



IMMISSIO 70

70 x 45 CM

H: 1 4 CM

⚖️ 28 KG

design by Valentino Marengo
2017

700 mm

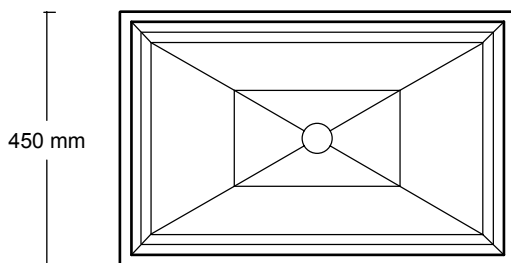

450 mm

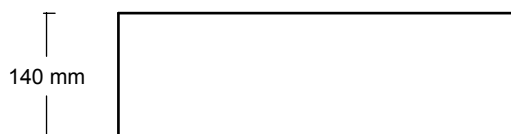

140 mm

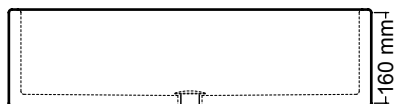
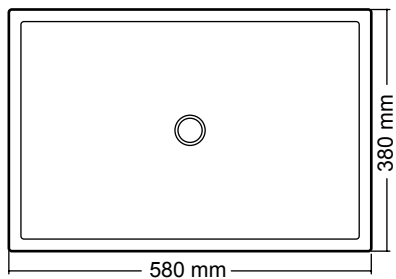

IMMISSIO 60

58 x 38 CM
H: 16 CM

⚠ 24 KG

design by Urbi et Orbi
2012

IMMISSIO 40

38 x 38 CM

H: 16 CM

⚠ 18 KG

design by Urbi et Orbi

2012

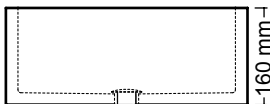
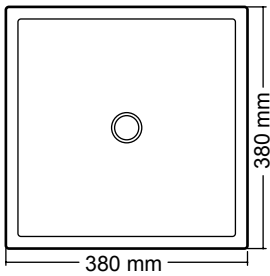
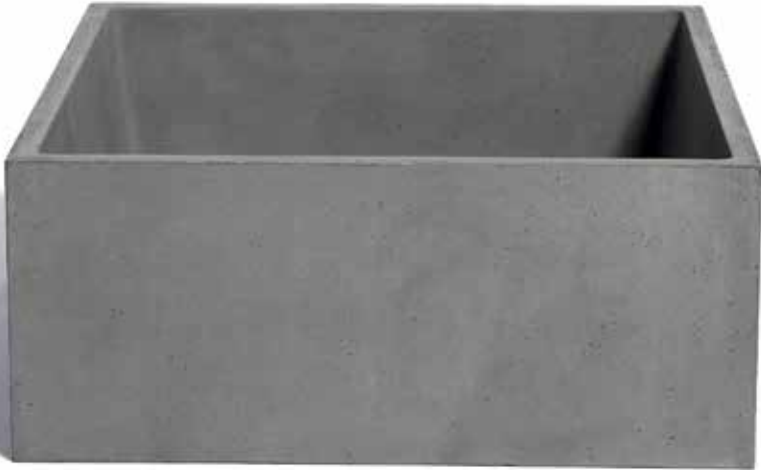

CONICIS 60

59 x 39 CM

H: 16 CM

🏠 19 KG

design by Urbi et Orbi

2013

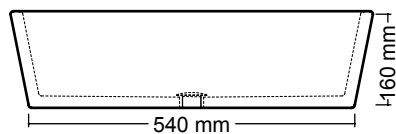
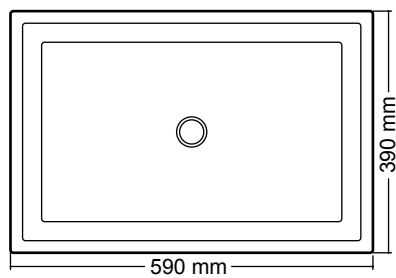



CONICIS 40

39 x 39 CM

H: 16 CM

⚖ 15 KG

design by Urbi et Orbi
2013

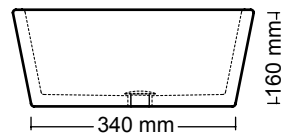
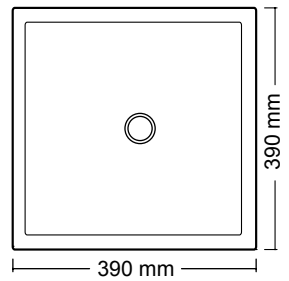



INVIVO 60

58 x 38 CM

H: 16 CM

⚖ 25 KG

design by Urbi et Orbi
2013

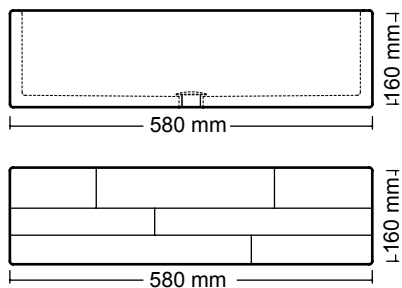
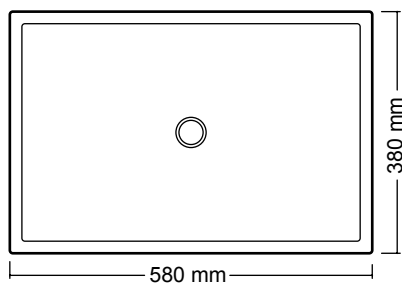

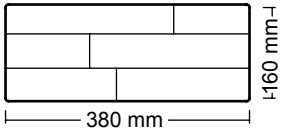
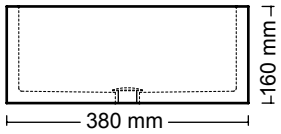
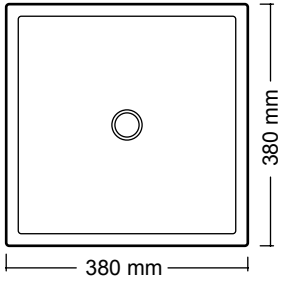

INVIVO 40

38 x 38 CM

H: 16 CM

👤 19 KG

design by Urbi et Orbi
2013

CIRCUM 42

D: 42 CM

H: 12 CM

⚖ 10 KG

design by Urbi et Orbi

2013

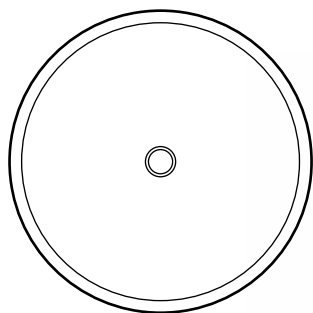

420 mm

120 mm

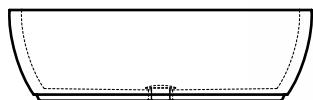

CIRCUM 48

D: 48 CM

H: 10 CM

👤 12 KG

design by Urbi et Orbi
2013

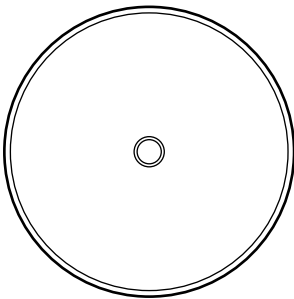

480 mm



100 mm





CIRCUM 40

D: 40 CM

H: 13 CM

⚠ 10 KG

design by Urbi et Orbi

2012

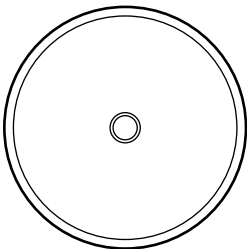

400 mm

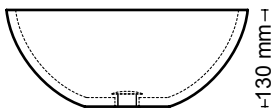

130 mm





CIRCUM 3817

D: 38 CM

BASE: 30 CM

H: 17 CM

⚖ 10 KG

design by Urbi et Orbi

2013

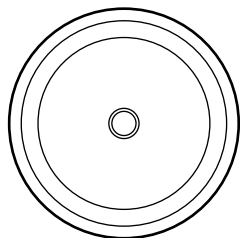

380 mm

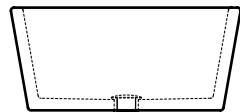

300 mm

170 mm





CIRCUM 3826

D: 38 CM

BASE: 26.5 CM

H: 26 CM

⚠ 10 KG

design by Urbi et Orbi
2013

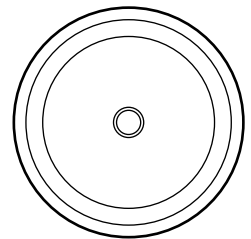

380 mm

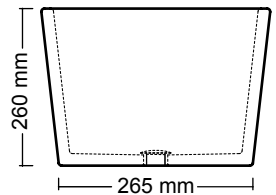

260 mm

265 mm

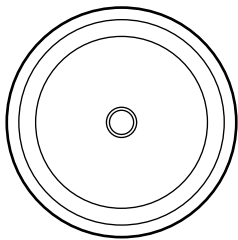

380 mm

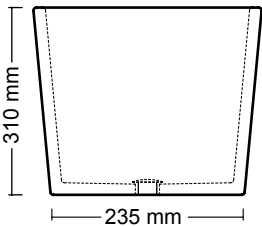

CIRCUM 3831

D: 38 CM
BASE: 23.5 CM
H: 31 CM

11 KG

design by Urbi et Orbi
2013



LIGHTING

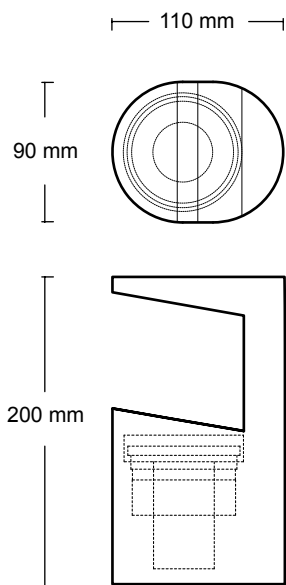

REF

LED MODULE IP65
11 x 9 CM
H: 20 CM

⚖ 1.5 KG

design by Valentino Marengo
2017



PAPEL

D: 7 CM
H: 27 CM

⚖ 1 KG

design by Valentino Marengo
2017

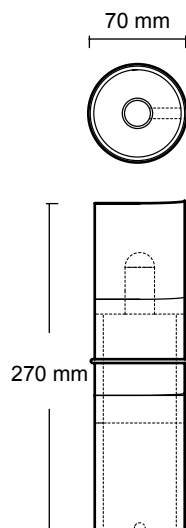

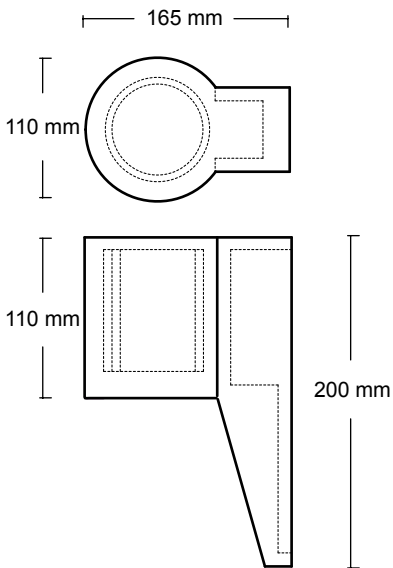

PROJECTA

LED MODULE IP65
16.5 x 11 CM
H: 20 CM

⚖ 2.5 KG

design by Valentino Marengo
2017



DESMI

LED MODULE IP65

34.5 x 10 CM

H: 13 CM

⚖ 3.5 KG

design by Valentino Marengo
2017

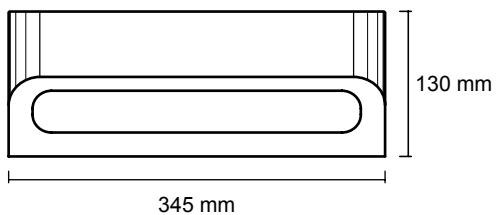
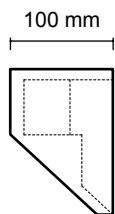



62 mm

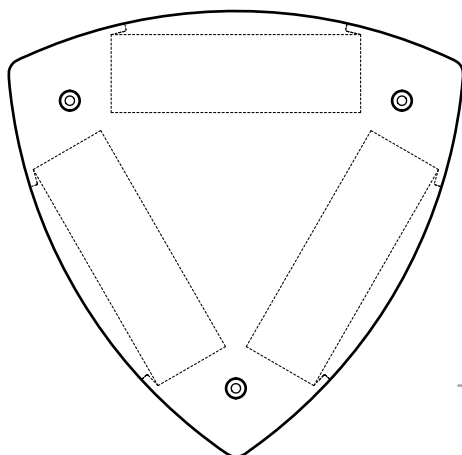
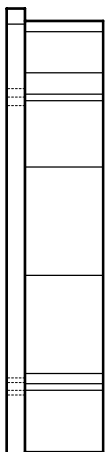

292 mm

DIATOMO

LED MODULE IP65

29.2 x 6.2 CM

⚖ 3.5 KG

design by Valentino Marengo
2017



“FUNKY” series

“FUNKY” series



ARETHA C

PENDANT LAMP

27 x 18 CM

DEPTH: 5CM

⚖ 1.5 KG

design by Urbi et Orbi
2016

ARETHA T

TABLE LAMP

27 x 18 CM

DEPTH: 5CM

⚖ 1.5 KG

design by Urbi et Orbi
2016





ARETHA W

WALL LAMP

27 x 18 CM

DEPTH: 5CM

⚖ 1.5 KG

design by Urbi et Orbi
2016

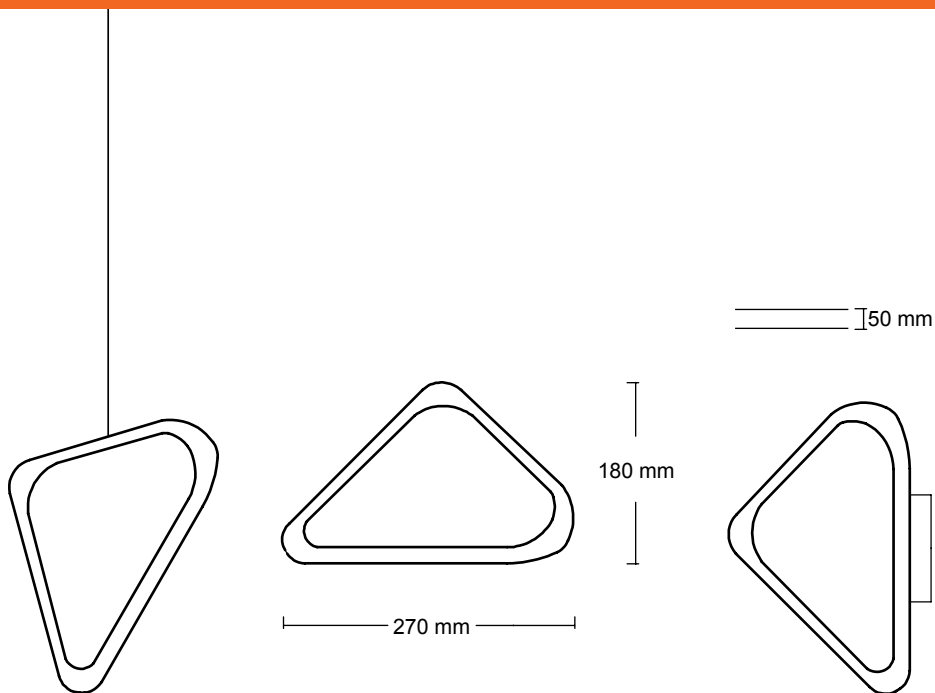

“FUNKY” series



GHETTO C

PENDANT LAMP

D: 19 CM

DEPTH: 5CM

⚖ 1 KG

design by Urbi et Orbi
2016

GHETTO T

TABLE LAMP

D: 19 CM

H: 40 CM

DEPTH: 5CM

⚖ 3 KG

design by Urbi et Orbi
2016





GHETTO W

WALL LAMP

D: 19 CM

DEPTH: 5CM

⚖ 1 KG

design by Urbi et Orbi
2016

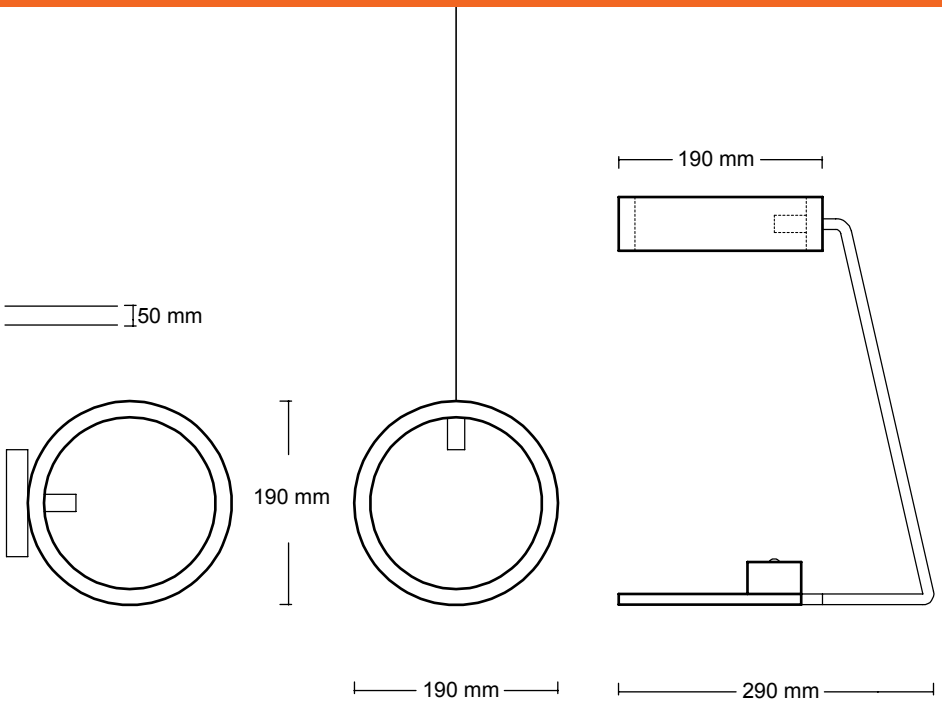

“FUNKY” series



SUPERFLY C

PENDANT LAMP

D: 17 CM

⚖ 1.5 KG

design by Urbi et Orbi
2016

SUPERFLY T

TABLE LAMP

D: 15 CM

⚖ 1.5 KG

design by Urbi et Orbi
2016





SUPERFLY W

WALL LAMP

D: 17 CM

⚖ 1.5 KG

design by Urbi et Orbi
2016

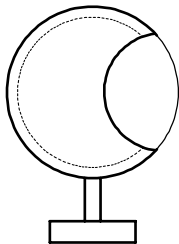

— 170 mm —

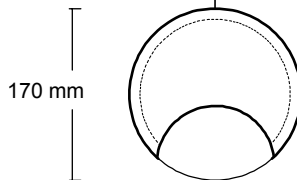

— 170 mm —

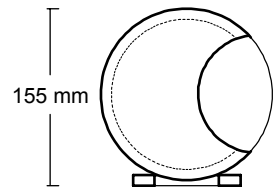

— 150 mm —

“FUNKY” series



MACEO W

WALL LAMP

H: 10 CM

D: 4 CM

⚖ 0.5 KG

design by Urbi et Orbi
2016

MACEO T

TABLE LAMP

H: 50 CM

⚖ 3 KG

design by Urbi et Orbi
2016



MACEO W2

WALL LAMP

H: 24 CM

D: 4 CM

⚠ 1 KG

design by Urbi et Orbi
2016

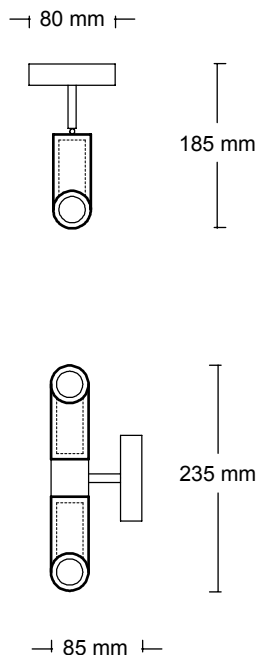
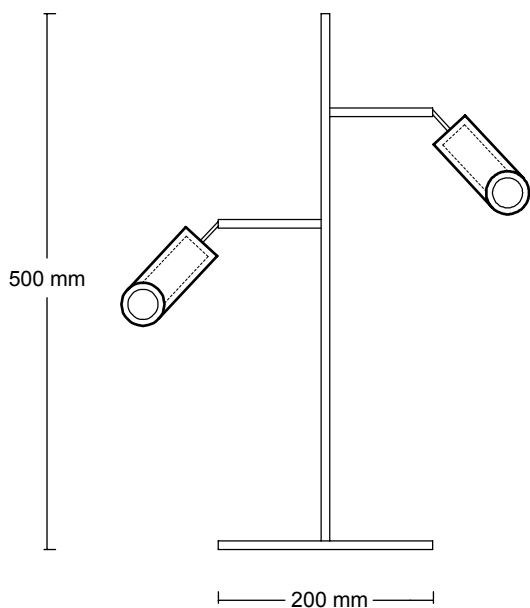



GLOBUS 410

D: 41 CM

H: 16.5 CM

⚠ 5.5 KG

design by Urbi et Orbi
2015

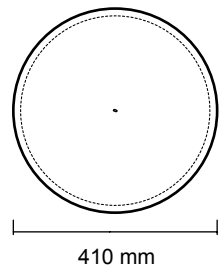
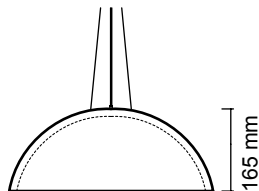



GLOBUS 280

D: 28 CM

H: 13 CM

⚠ 2 KG

design by Urbi et Orbi
2012

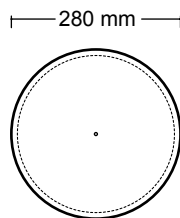
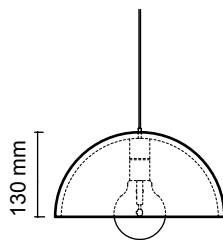

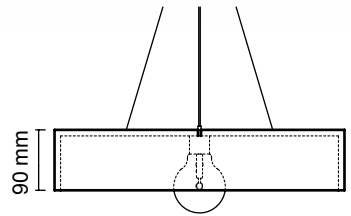

ROTA

D: 48 CM

H: 9 CM

⚠ 9 KG

design by Urbi et Orbi
2013

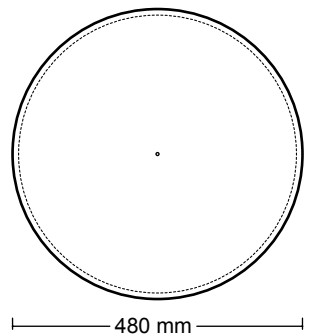



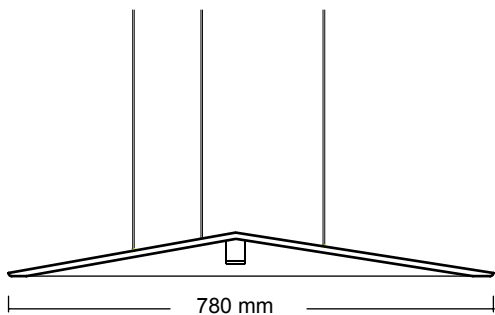
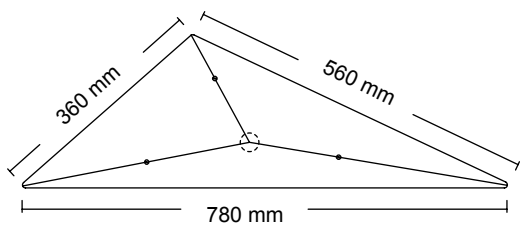

led 3.5 watt

HERON

⚠ 3 KG

design by Urbi et Orbi
2014

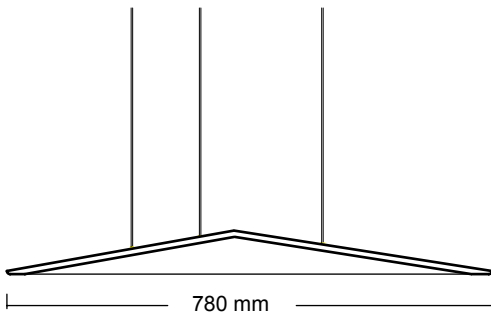
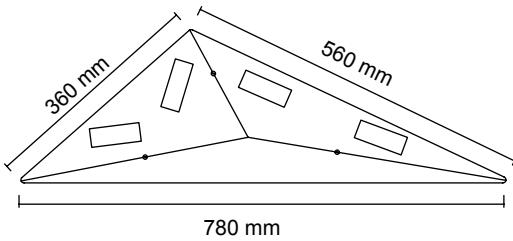

led 12 watt
HERON

3 KG

design by Urbi et Orbi
2014



BATTAGLIA 210

D: 21 CM

H: 31 CM

⚖ 5.5 KG

design by Urbi et Orbi
2015

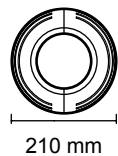
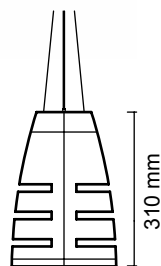



BATTAGLIA 150

D: 15 CM

H: 21 CM

1 1 KG

design by Urbi et Orbi
2015

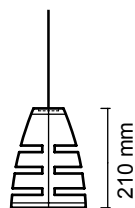

150 mm

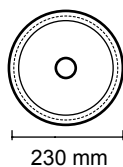
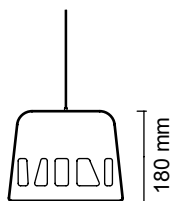

LUNA

D: 23 CM

H: 18 CM

⚖ 3.7 KG

design by Urbi et Orbi
2015



HEDERA

D: 26 CM

H: 28 CM

⚖ 7.7 KG

design by Urbi et Orbi

2015

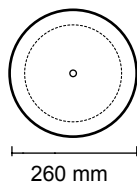
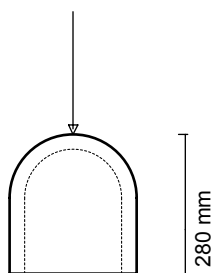

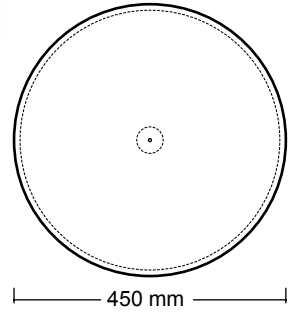
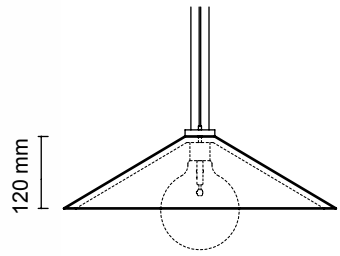

MONS 45

D: 45 CM

H: 12 CM

⚖ 4.5 KG

design by Urbi et Orbi
2012





MONS 28

D: 28 CM

H: 12 CM

⚖ 2.5 KG

design by Urbi et Orbi
2012

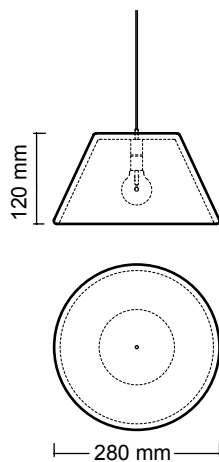



IGNIS NOX

D: 8 CM

H: 59 CM

⚖ 2.5 KG

design by Urbi et Orbi
2015



IGNIS VER

D: 8 CM

H: 59 CM

2 KG

design by Urbi et Orbi
2015

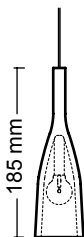
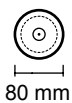

AMPULLA

D: 8 CM
H: 18.5 CM

0.85 KG

design by Urbi et Orbi
2013



PHARI

D: 8 CM
H: 18 CM

⚖ 1.3 KG

design by Urbi et Orbi
2013

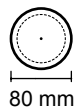
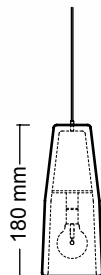



CYLINDRUS 125

D: 12.5 CM

H: 23 CM

👤 2.5 KG

design by Urbi et Orbi
2013

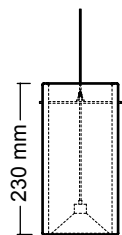
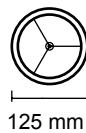

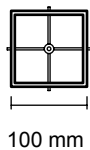
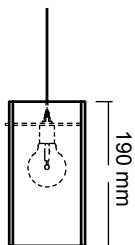

INEST

10 x 10 CM
H: 9 CM

1.5 KG

design by Urbi et Orbi
2014

CALIX 18

D: 18 CM

H: 16 CM

⚖ 2 KG

design by Urbi et Orbi
2012

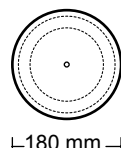
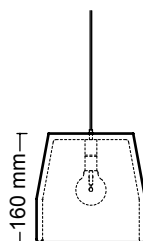

CALIX 14

D: 14 CM

H: 13 CM

⚖ 0.8 KG

design by Urbi et Orbi
2012

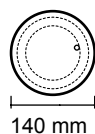
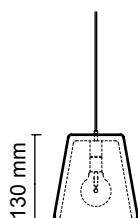

DOLIO Q

D: 7 CM
H: 9 CM

⚖ 0.4 KG

design by Urbi et Orbi
2012

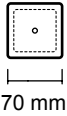
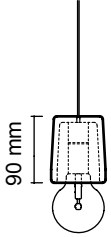

DOLIO

(M) D: 6 CM – H: 9 CM
(L) D: 7 CM – H: 10 CM

⚖ (M) 0.25 KG - (L) 0.5 KG

design by Urbi et Orbi
2012

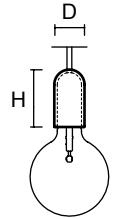

AMPULLA PIC

D: 6 CM
H: 9 CM

⚖ 0.3 KG

design by Urbi et Orbi
2012

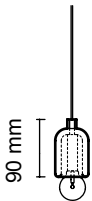



LANTERN

FLOOR LAMP

LED MODULE IP65

23 x 23 CM

H: 31 CM

⚠ 6 KG

design by Urbi et Orbi

2014

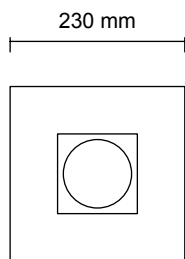
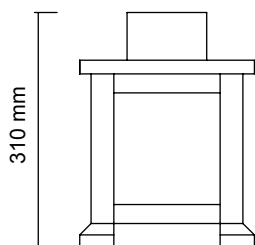

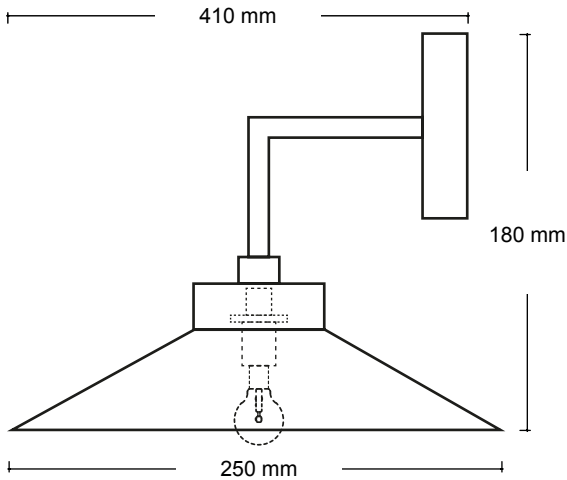

STRADA

D: 25 CM

H: 18 CM

L: 41CM

⚖️ 2 KG

design by Urbi et Orbi
2015



QUADRATA X

30 x 30 CM

H: 9 CM

⚖ 3.5 KG

design by Valentino Marengo

2015

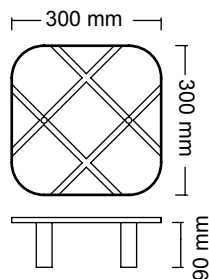

QUADRATA N

30 x 30 CM

H: 9 CM

⚖ 3.5 KG

design by Valentino Marengo

2015

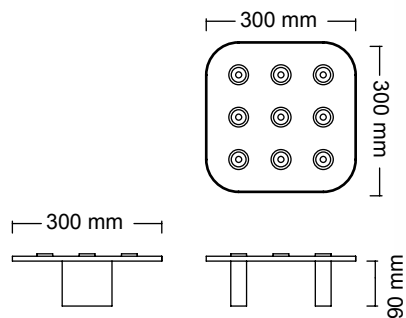

QUADRATA G

30 x 30 CM

H: 9 CM

⚖ 3.5 KG

design by Valentino Marengo

2015

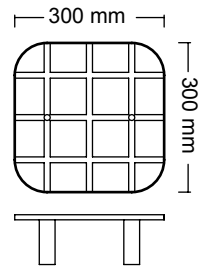

QUADRATA L

30 x 30 CM

H: 9 CM

⚖ 3.5 KG

design by Valentino Marengo

2015

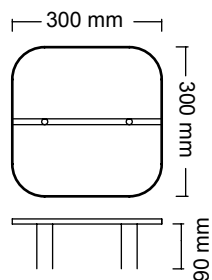

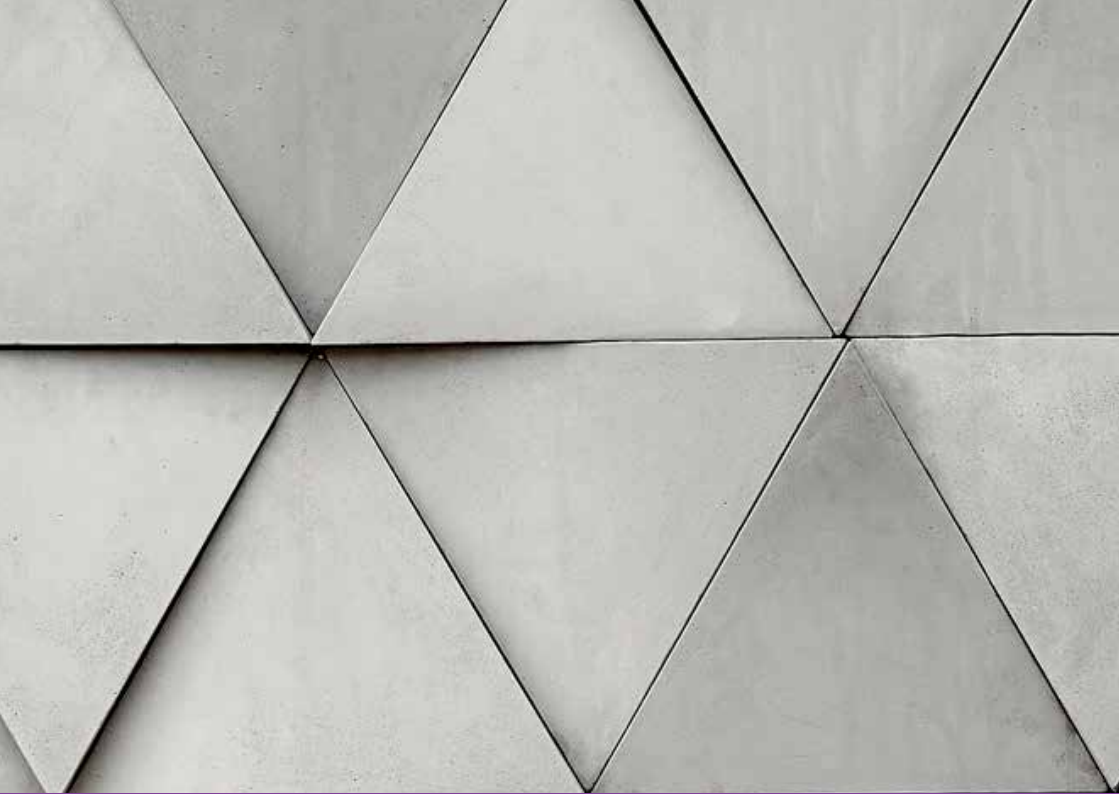

WALL TILES

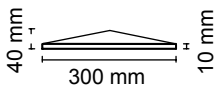
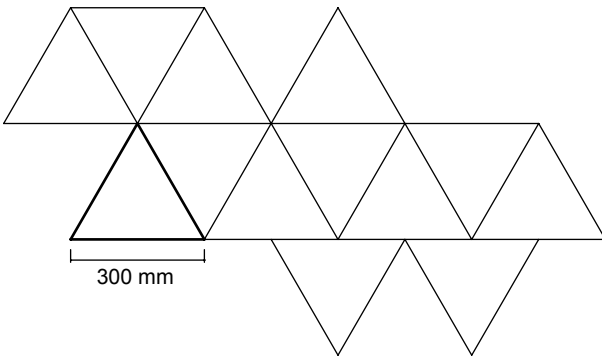

EUCLID

THICKNESS : 1 - 4 CM

1.8 KG/PC

design by Urbi et Orbi
2014

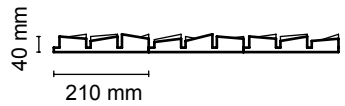
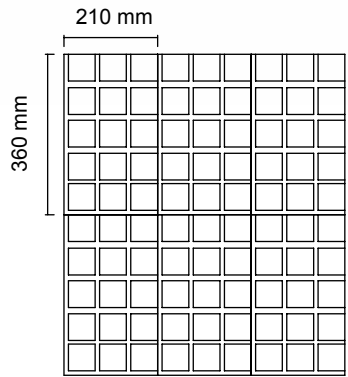
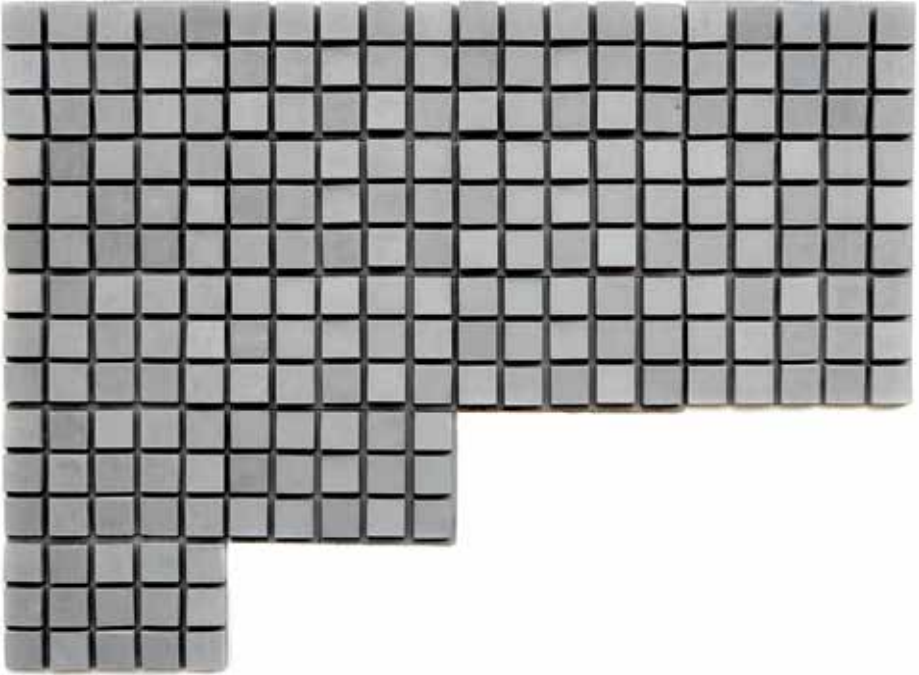

PLANTED CUBES

THICKNESS : 2 - 4 CM

⚖ 4 KG/PC

design by Urbi et Orbi
2014



1000 mm



NUDUS

THICKNESS : 1CM

2.1 KG/PC

design by Urbi et Orbi
2014

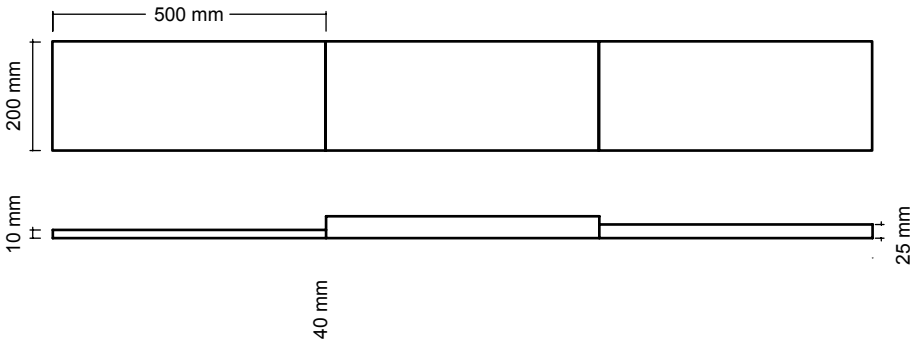
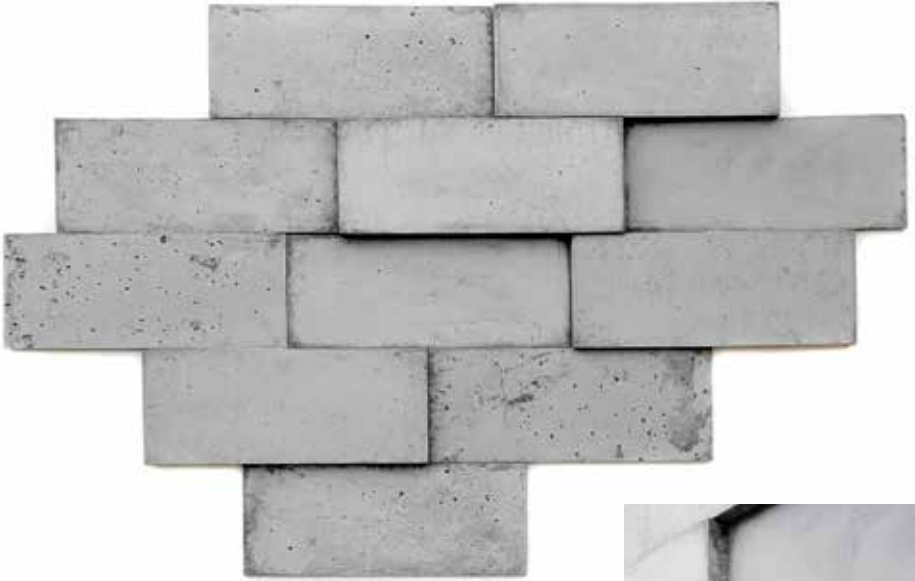

PANELO 3D

THICKNESS : 1-2.5-4 CM

🏗️ 2.1 - 5 - 8.3 KG/PC

design by Urbi et Orbi
2014



MURUS

THICKNESS : 2 CM

⚖ 42 KG/PC

design by Urbi et Orbi
2013

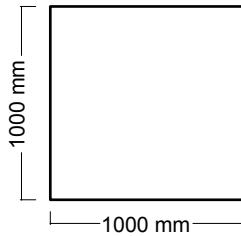

METAL FORM

THICKNESS : 2 CM

⚖ 42 KG/PC

design by Urbi et Orbi
2013

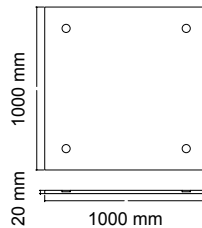

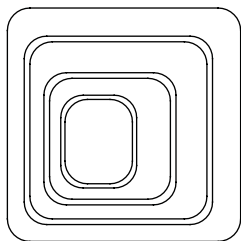

TESSERA

41.5 x 41.5 CM
31.5 x 31.5 CM
21.5 x 21.5 CM
12 x 15 CM

design by Urbi et Orbi
2016

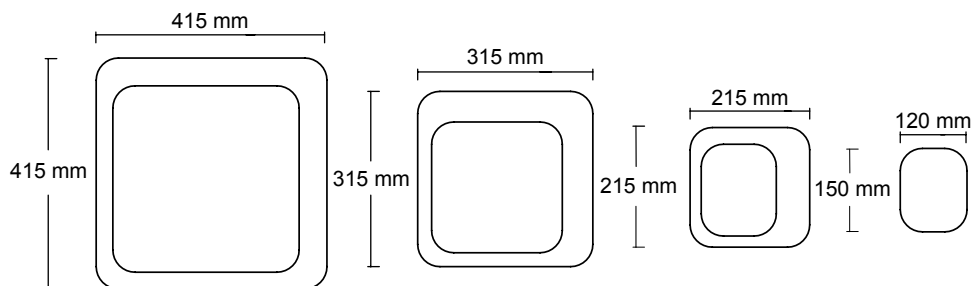



GRID

5 x 5 CM

design by 2vlo
2017

AVAILABLE IN 6 COLORS

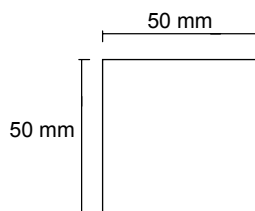

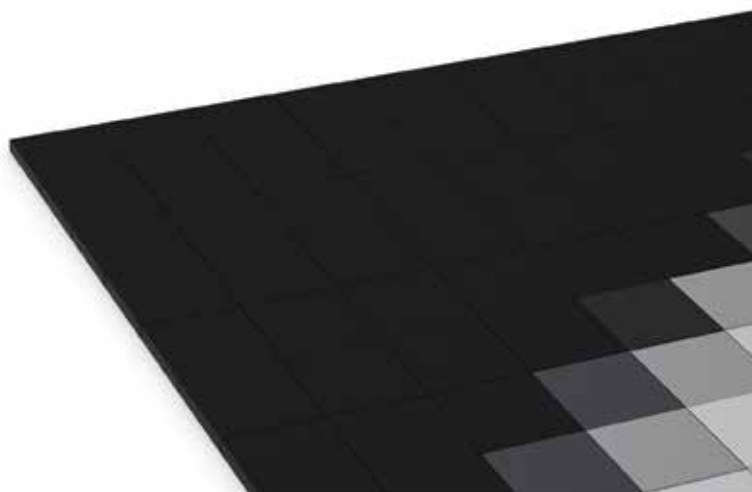
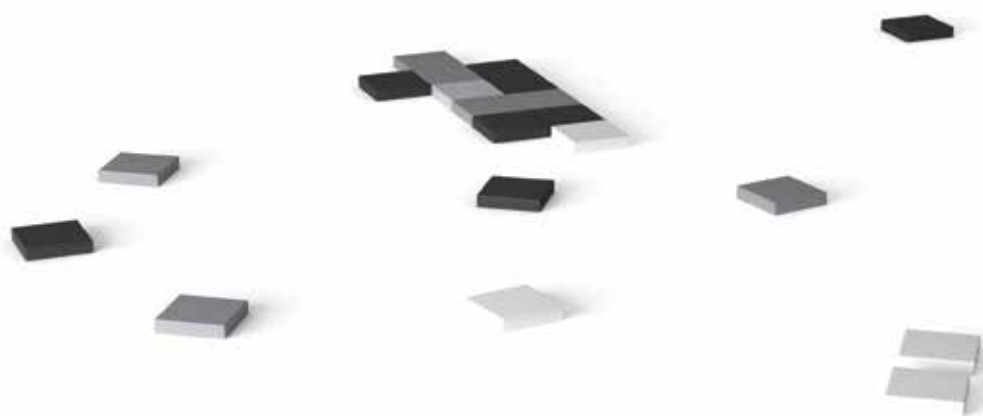

ACCESSORIES





MARINE

KNOB/HANGER

design by 2vlo
2014

SMALL	MEDIUM	LARGE (M4-M8)
A-A1: 12MM	A2: 16MM	A3: 22MM
B-B1: 44MM	B2: 54MM	B3: 75MM
C-C1: 44MM	C2: 59MM	C3: 81MM

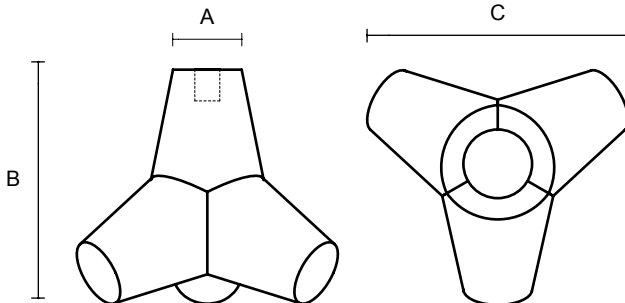



POMOLO

KNOB/HANGER

D: 4 - 7 - 9 CM

M4 - M8

design by 2vlo
2013

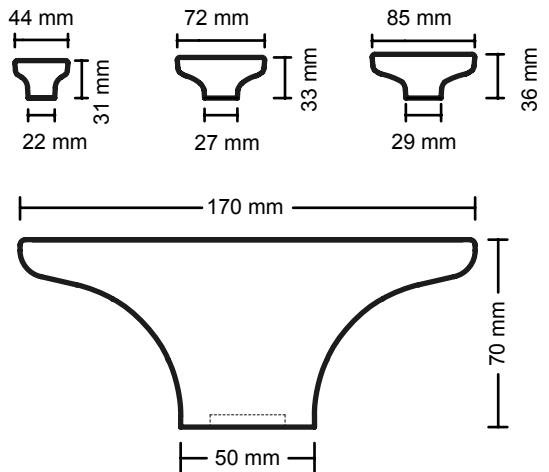



CUBE PLATE

H: 8 CM

⚖ 4 KG

design by Valentino Marengo
2014

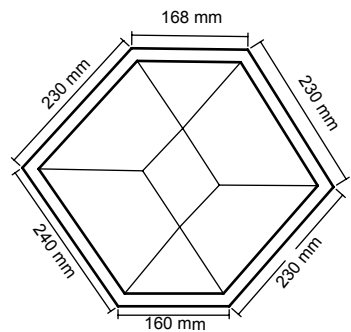



ULTIMA

D: 15 CM

H: 8.5 CM

⚖ 1 KG

design by Valentino Marengo
2017

150 mm

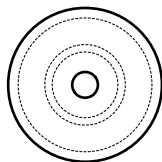

85 mm

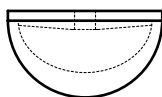

FUMI

21 x 21 CM

H: 4.5 CM

👤 2 KG

design by Urbi et Orbi
2012

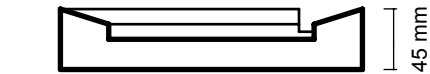
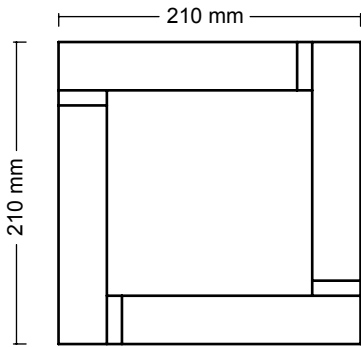



550 mm

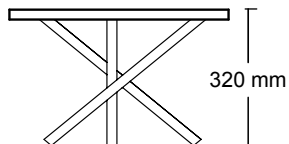
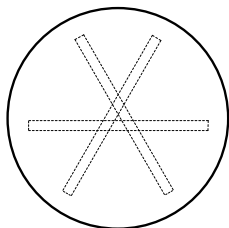

NODO

D: 55 CM

H: 32 CM

11 KG

design by Valentino Marengo
2015



MENSA ROTA

40 x 40 CM
H: 45 CM
THICKNESS : 2CM

👤 25 KG

design by Urbi et Orbi
2013

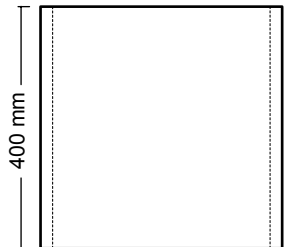
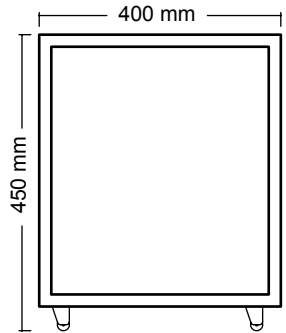

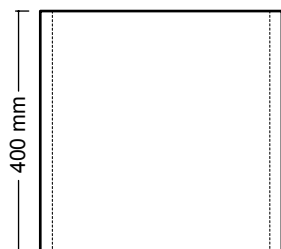

STUDY

20 x 40 , 20 x 20 CM
THICKNESS 2 CM
DEPTH : 25 CM

⚖ 14-11 KG

design by Urbi et Orbi
2013

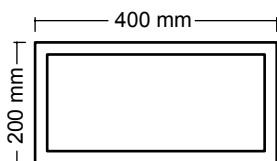
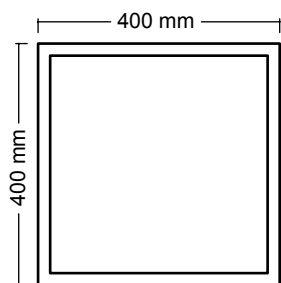

TEMPUS 32

D: 32 CM

⚖ 3 KG

design by Urbi et Orbi
2013

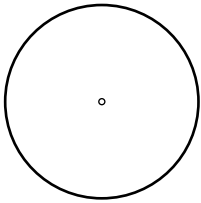

320 mm



30 mm







Urbi et Orbi

S : www.urbietorbi.gr

E : info@urbietorbi.gr

T : 0030 210 4520178

Cast Concrete Elements
